



# MERCHANT REFERENCE GUIDE

Processing of EMV Chip Cards , Contactless Cards ,  
and Contactless Devices or Wearables  Using Verifone.

**V200c+, V200t+, & V240m+**

# TABLE OF CONTENTS

OVERVIEW OF TERMINAL MODELS	1
V200c+	2
V200t+	14
V240m+	24
START-UP INSTRUCTIONS AND ACCESS MANAGEMENT	31
SALE	34
PRE-AUTHORIZATION AND PRE-COMPLETION	37
REFUND AND VOID	39
TERMINAL ADMINISTRATION, MANAGEMENT, AND SETTLEMENT	41
CONNECTIVITY OPTIONS	44
TERMINAL CARE AND MAINTENANCE	46
PASSWORD MAINTENANCE	48
MERCHANT SUPPORT CHANNELS	49



# OVERVIEW OF TERMINAL MODELS

V200c+, V200t+,  
& V240m+

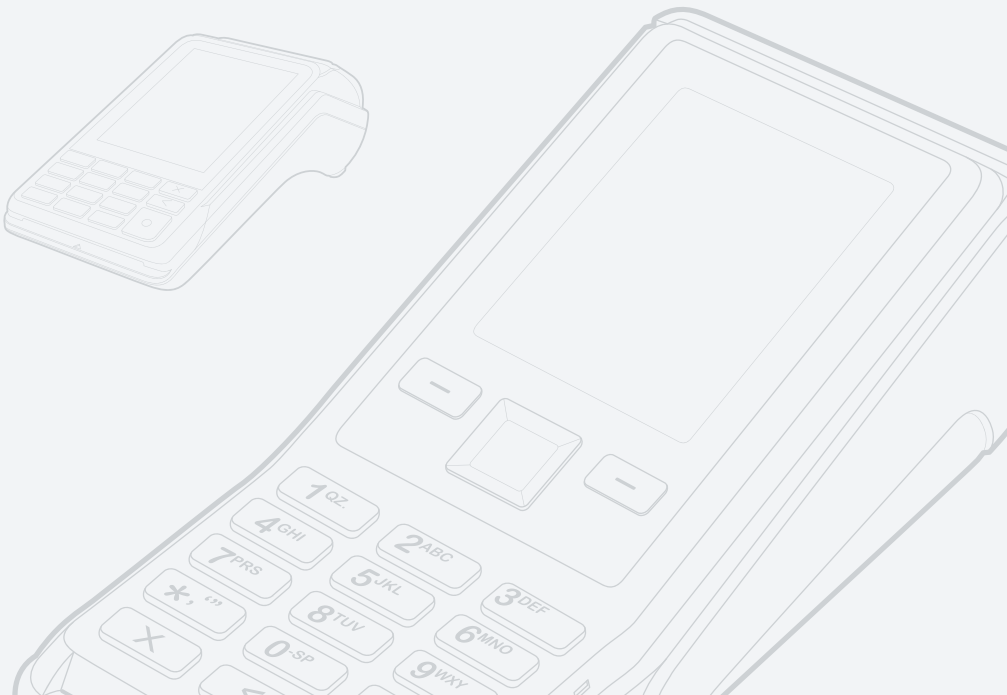

# V200c+

---

As part of Verifone's Engage portfolio, the V200c+ terminal boasts cutting-edge technology within its features, functionality, and versatility. It offers more speed, an interactive user interface, and enhanced security to ensure that your customers have a unique point-of-sale experience.

---



# V200c+

## NAVIGATIONAL COMPONENTS OF V200c+

The V200c+ has three colour-coded function keys below the keypad (from left to right: **X** CANCEL, **<** BACKSPACE/CLEAR, **O** ENTER).

## TERMINAL FEATURES

It has physical navigation and selection keys:

B1 - A backlit 12-key keypad.

[B3] 4-way navigation button centered at the top of the keypad, below the LCD screen.

[B4] Two selection keys on the left and right side of the navigation button.

C - A magnetic card reader is built into the right side. The icon shows the proper swipe direction, with

the stripe down and facing inward, towards the keypad.

D - A smart card reader is built into the front of the terminal. The icon indicates the proper card position and insertion direction.

E - The internal thermal printer opens towards the rear of the unit.

### Note:

- *The screen also acts as a tapping area for Contactless transactions.*

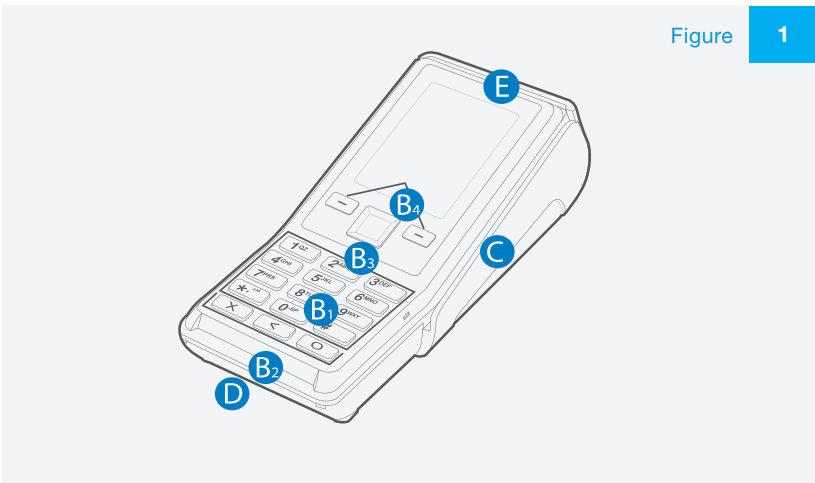
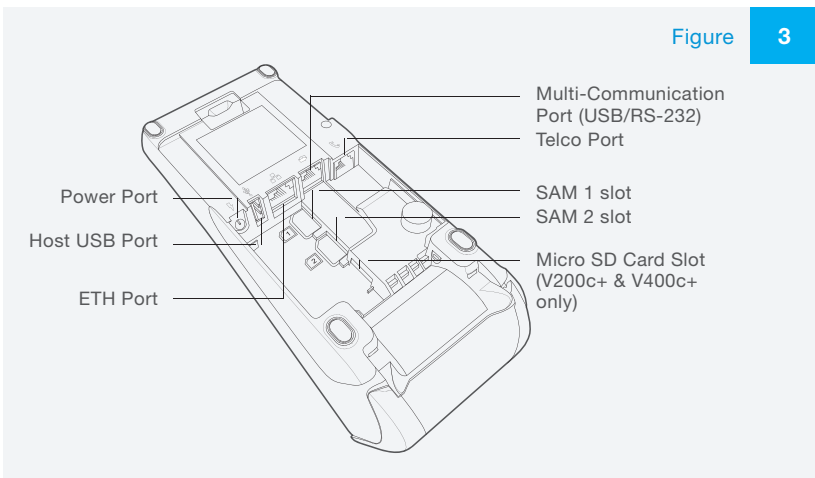
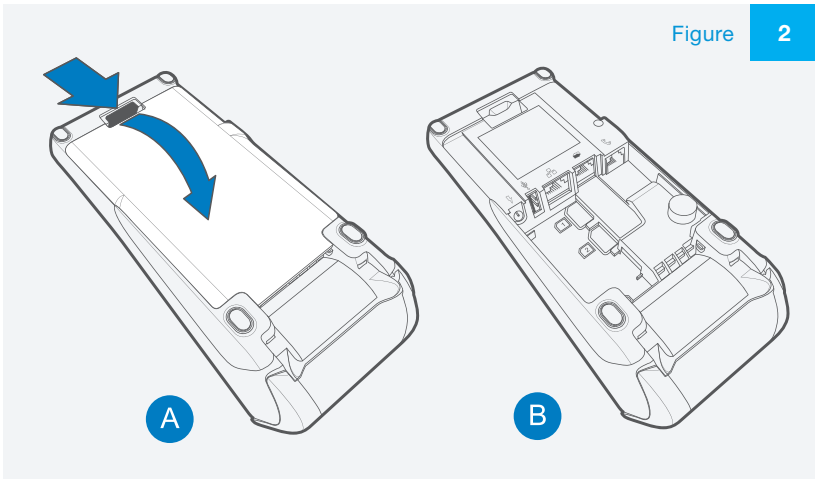

Figure 1

## CONNECTION PORTS

To view the connection ports, simply turn the device around and unfasten the rear cover. There, you will see the various ports that provide connections to communication lines, optional peripheral devices, and the power supply.

Figure 3 shows the power, communications, and connection ports for the V200c+ terminal.



---

## CONNECTION PORTS (continued)

The connection ports offer multiple connectivities for the V200c+ terminal, such as Ethernet or Dial-Up.

Please refer to the following list of peripheral devices for the connectivity options:



Host USB Port: PIN Pads



Ethernet (ETH) Port: Ethernet cable to router, hub, or switch



Multi-Communication Port (USB/RS-232): PIN Pads



Telco Port: Telephone line

## ESTABLISHING CONNECTION

You can connect the V200c+ terminals to a telephone line and/or Ethernet cable. You can also connect via Wi-Fi.

### CONNECTING BY TELEPHONE LINE

Connect the telephone cord to the communication port on the terminal, then route it directly to a telephone wall jack. This is a direct connection and the line is dedicated to the terminal (*figure 4*).

### CONNECTING BY ETHERNET

Connect the Ethernet cable to the ETH port on the terminal, then route it directly to a network jack. This is a direct connection to your network (*figure 5*).

Figure

4

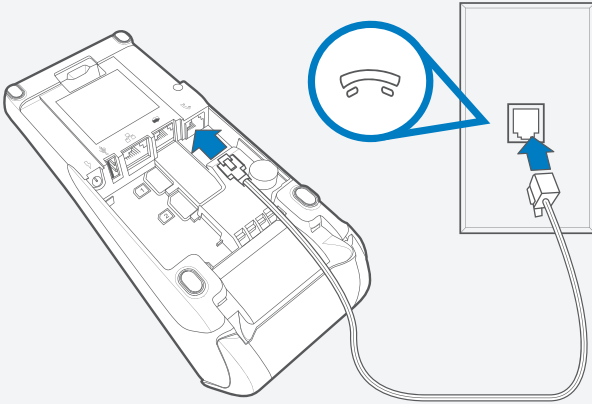

Figure

5

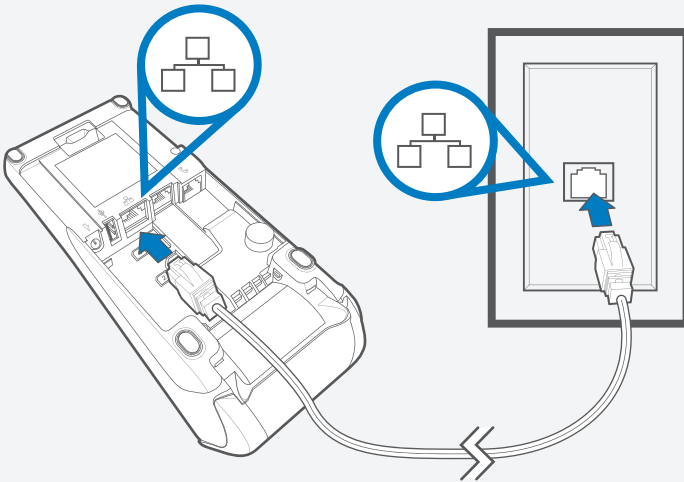



## SETTING UP WI-FI CONNECTIVITY

01. From the Main Menu screen, press '#’.
02. Select 'Management’.
03. Select 'Settings’.
04. Select 'Communications’.
05. Enter the Manager password to set up terminal connectivity (LAN, Wi-Fi, etc.).
06. Select 'Wi-Fi’, then press 'Enter’ (terminal scans for Wi-Fi networks).
07. Choose from the list of Wi-Fi networks, then press 'Enter’.
08. Input the Wi-Fi password, then press 'Enter’.
09. Press 'Enter’ to exit after the Wi-Fi password is accepted.

### Note:

- To utilize special characters for your Wi-Fi password, select the asterisk symbol (\*), the number key zero (0), and the pound key (#) in that order; in quick succession, to produce a variety of special characters.
- The asterisk (\*) symbol produces the following characters: , ‘ “
- The zero (0) key produces the following characters: - +
- The pound key (#) produces the following characters: ! ; @ = & / \ % \$ ( ) ^ \_

## HOW TO USE THE TERMINAL'S CONTACTLESS READER

### To perform a contactless credit or debit card transaction:

01. Gently tap or hold the card on the landing zone.
02. A short beeping sound indicates a successful transaction (figure 6).



Figure

6

## HOW TO USE THE TERMINAL'S CHIP CARD READER

### To conduct an EMV or chip credit or debit card transaction:

01. Position a chip card with the contacts facing upward.
02. Insert the chip card into the chip card reader slot in a smooth, continuous motion until it seats firmly (*figure 7*).
03. Remove the card only when the application indicates the transaction is complete.

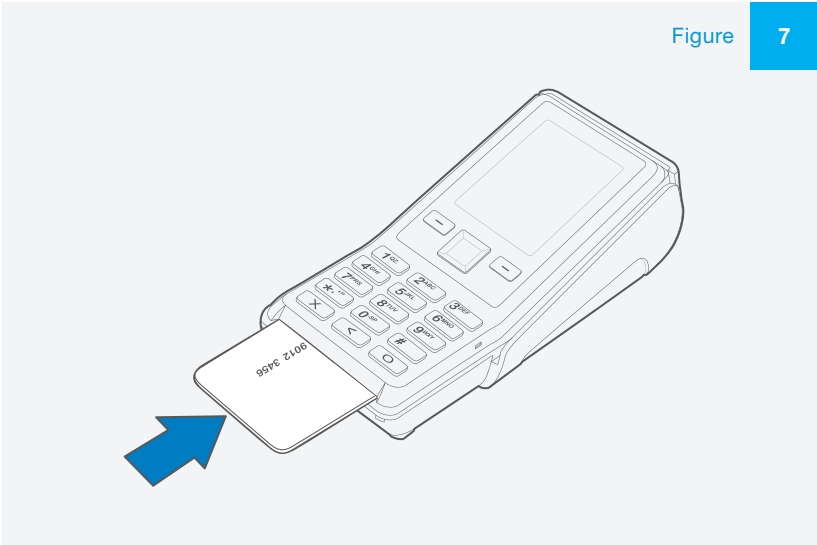

## HOW TO USE THE TERMINAL'S MAGNETIC CARD READER

### To conduct a credit or debit magstripe card transaction:

01. Position the card with the magnetic stripe oriented downward, facing the keypad.
02. To ensure a proper read of the magnetic stripe, swipe the card smoothly through the reader in one direction (either towards the top of the screen or the bottom of the keypad).
03. Check the screen for confirmation of a successful transaction.

Figure

8

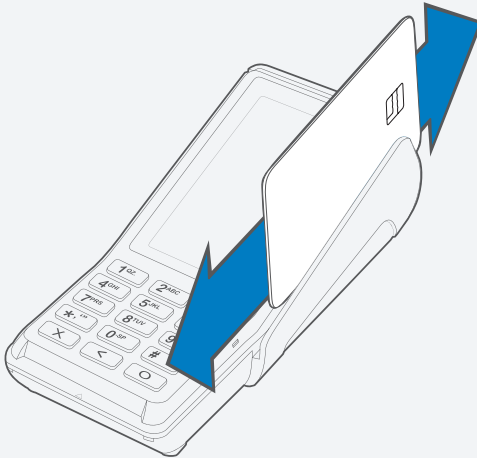

## HOW TO CONNECT TO A PIN PAD

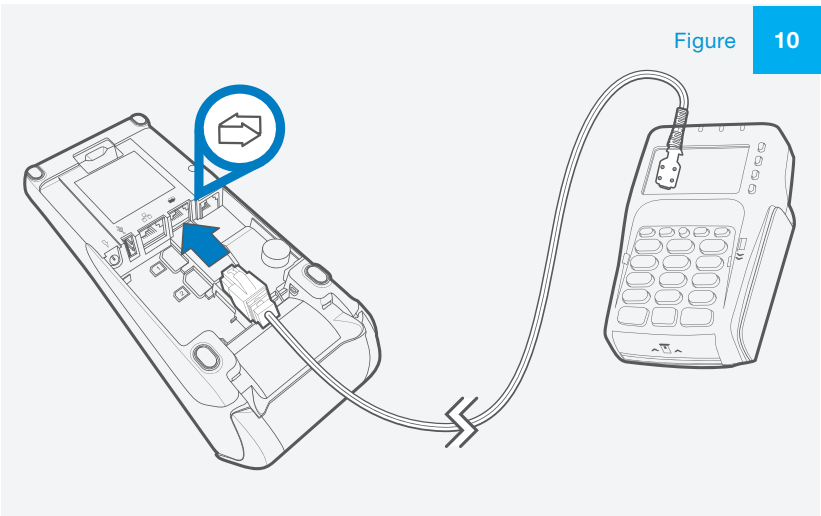
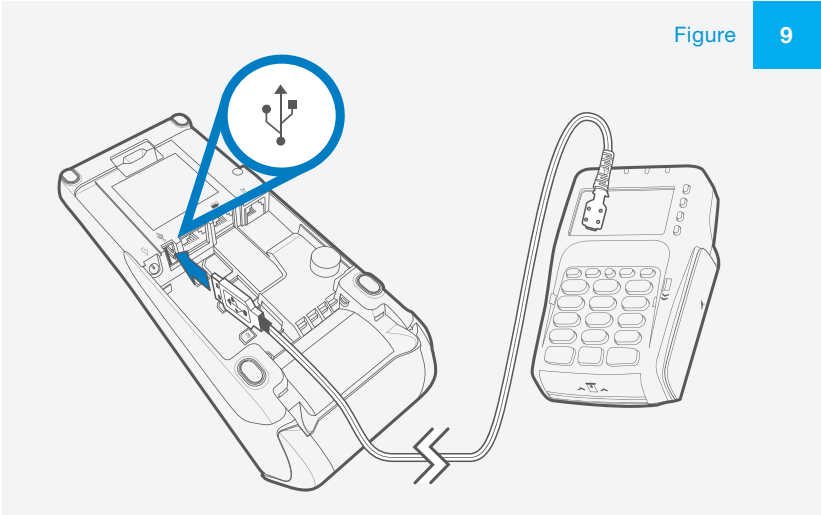

## CONNECTING THE TERMINAL'S POWER SUPPLY

01. Remove the terminal's rear cover to access the power port.
02. Insert the round barrel connector (*figure 11*) into the power port.
03. Route the cable in the direction of the arrow above the power port and sling the cable over the underside of the thermal paper container.
04. Close the terminal's rear cover.
05. Plug the AC power pack into a wall outlet or powered surge protector.

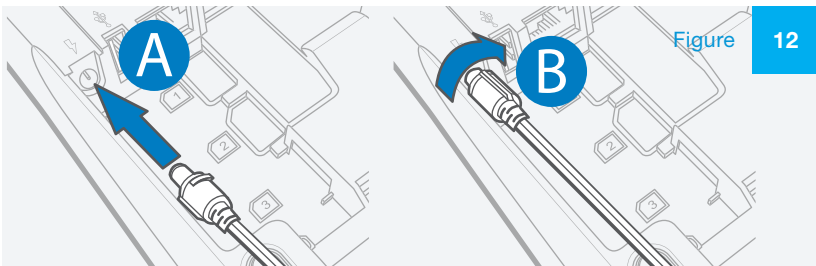
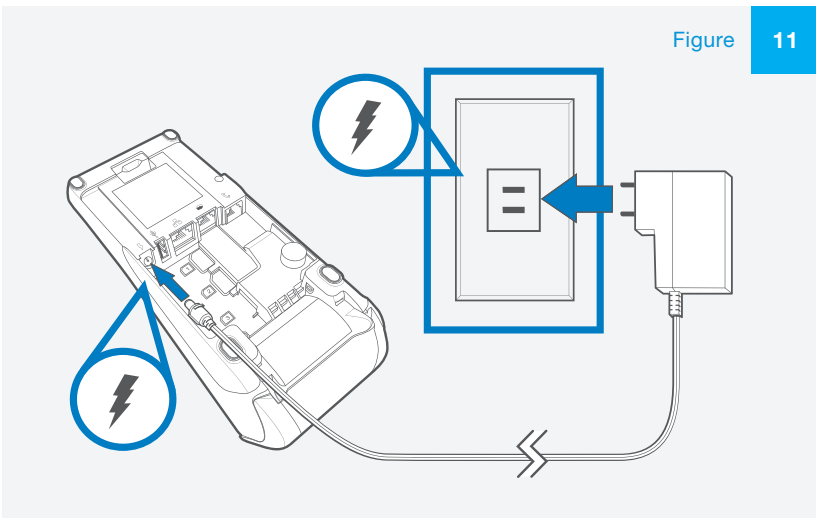

## LOADING A ROLL INTO THE TERMINAL'S PRINTER

Before you can process transactions that require a receipt, you must install paper in the printer.

01. Hook your finger under the latch and lift up to swing the paper roll cover open (*figure 13*). Remove any partial roll of paper in the printer tray by lifting it up.
02. Loosen the glued leading edge of the new paper roll or remove the protective strip. Unwind the paper roll past any glue residue.
03. Hold the roll, so the paper feeds from the bottom of the roll.
04. Load the paper roll as shown in *figure 14* with the edge of the paper on the top of the roll.

05. Swing the paper roll cover until it clicks shut, allowing a small amount of paper (past the glue residue) to extend outside the printer door (*figure 15*).

### Note:

- A pink out-of-paper indicator line appears on the edge of the paper before the end of the roll. After this line appears, there is enough paper remaining on the roll to print at least one more transaction receipt.
- If the printer is not printing the receipt, the merchant should turn the roll over.
- It is important to note that our printers are thermal printers and do not use ink.

Figure 13

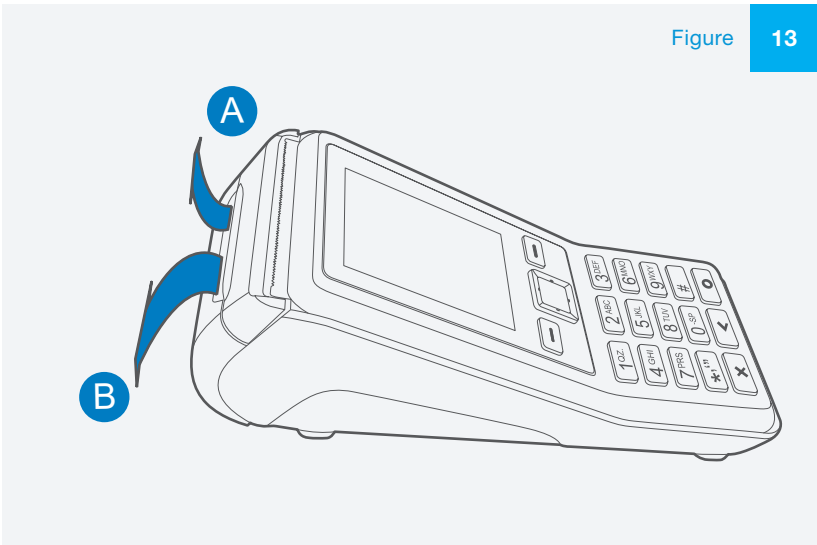

## LOADING A ROLL INTO THE TERMINAL'S PRINTER (continued)

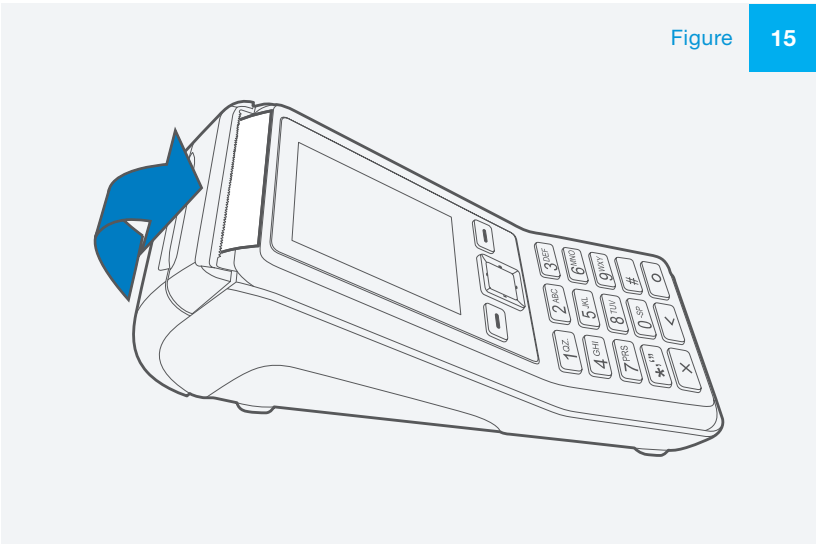
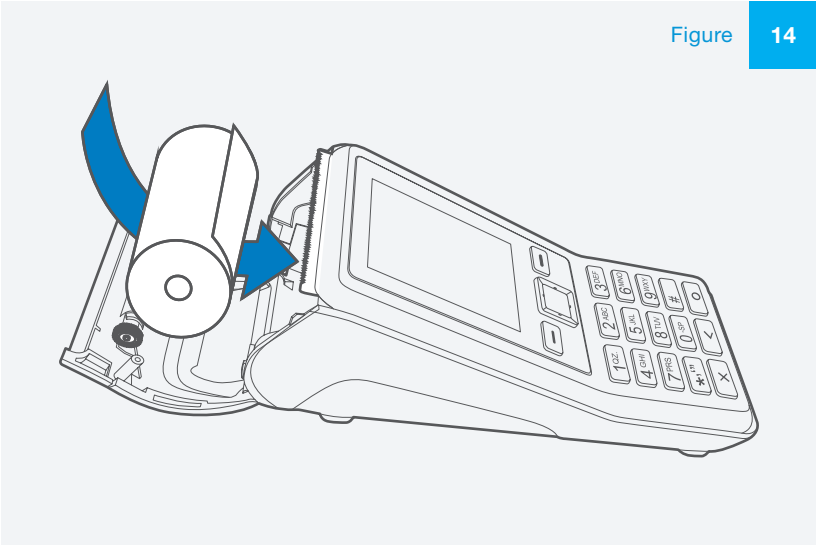

# V200t+

---

**The V200t+ is an all-in-one, dual-function payment device in Verifone's Engage portfolio that functions as both a countertop and a portable payment solution.**

As a countertop payment solution, it employs the use of Dial-up or Ethernet connectivity, while as a portable payment solution, it engages its built-in battery and wireless radio components. The V200t+ terminal has a bold, sleek design and is a lightweight device that

can be conveniently handed to the Customer to enter the PIN or other input.

This terminal comes equipped with the latest, next-generation features and functionality, such as increased processing power, memory, an interactive user interface, and enhanced security capabilities. With this terminal, your customers will have a seamless experience at the point of sale.

---





# V200t+

## NAVIGATIONAL COMPONENTS OF V200t+

The V200t+ offers several communication options, an enhanced display, and increased processing power.

The V200t+ terminal uses a robust, sleek, and highly functional design with modular communication options, enhanced colour display, increased processing power, expanded memory, and two USB peripheral ports.



Figure 16

## TERMINAL FEATURES

The V200t+ terminal provides the right combination of features and functions:

- 2.8 inch TFT colour screen.
- 4-way Navigation Button with Selection Keys.
- Backlit keypad with tactile and audible feedback.
- Contactless (CTLS) card reader (which offers a convenient payment option for customers).
- EMV Chip card reader.
- Magnetic Stripe card reader.
- Integrated thermal printer.

After removing the rear covers of the V200t+, you can access the terminal's rear components, such as:

- Dual Sim slots.
- Battery compartment.
- Ethernet port.
- Power port.

(see figures 17 & 18)

Figure 17

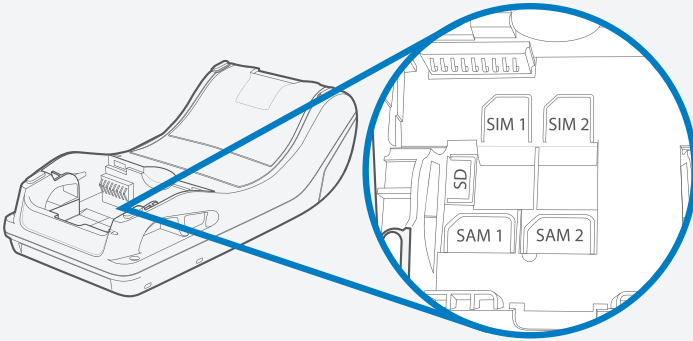
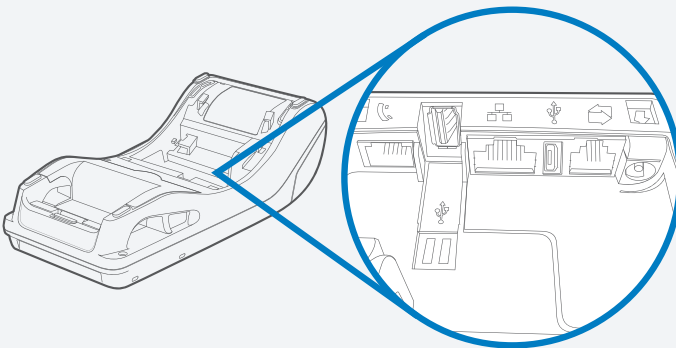

Figure 18



## ESTABLISHING CONNECTION

You can connect the V200t+ terminal to your network by using the following options:



Connecting by Telephone Line



Connecting by Ethernet Cable

Additional connection media include:



Wi-Fi



GPRS/DATA SIM

## CONNECTING BY TELEPHONE LINE

Connect the telephone cord to the communication port on the terminal, then route it directly to a telephone wall jack. This is a direct connection and the line is dedicated to the terminal (*figure 19*).

## CONNECTING BY ETHERNET CABLE

Connect the ethernet cable to the ETH port on the terminal, then route it directly to a network jack. This is a direct connection to your network (*figure 20*).

## SETTING UP WI-FI CONNECTIVITY

01. From the Main Menu screen, press '#’.
02. Select ‘Management’.
03. Select ‘Settings’.
04. Select ‘Communications’.
05. Enter the Manager password to set up terminal connectivity (LAN, Wi-Fi, etc.).
06. Select ‘Wi-Fi’, then press ‘Enter’ (terminal scans for Wi-Fi networks).
07. Choose from the list of Wi-Fi networks, then press ‘Enter’.
08. Input the Wi-Fi password, then press ‘Enter’.
09. Press ‘Enter’ to exit after the Wi-Fi password is accepted.

### Note:

- To utilize special characters for your Wi-Fi password, select the asterisk symbol (\*), the number key zero (0), and the pound key (#) in that order; in quick succession, to produce a variety of special characters.

Note (continued):

- The asterisk (\*) symbol produces the following characters: , ‘ “
- The zero (0) key produces the following characters: - +
- The pound key (#) produces the following characters: ! : ; @ = & / \ % \$ ( ) ^ \_

Figure 19

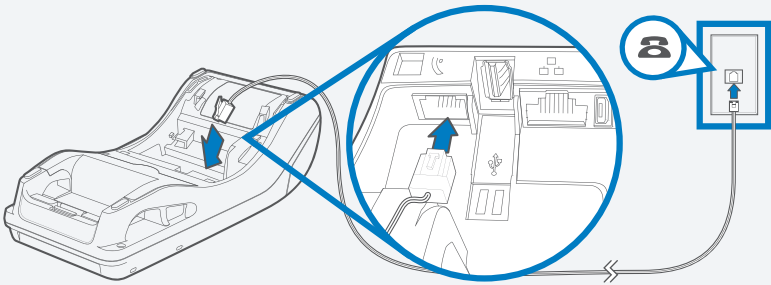
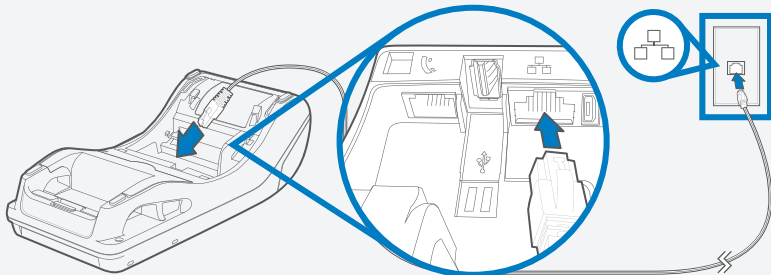
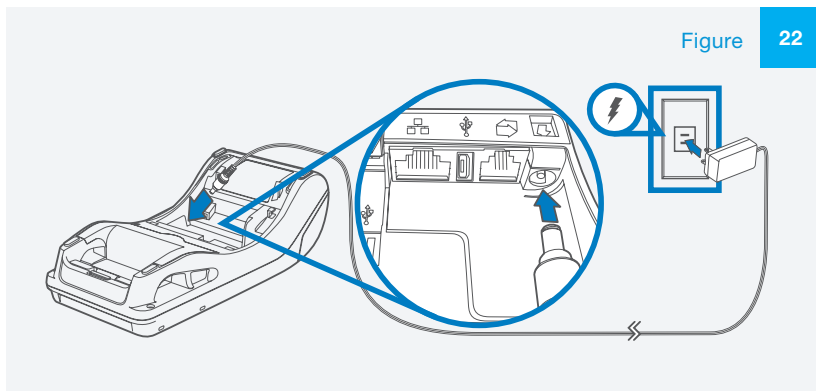
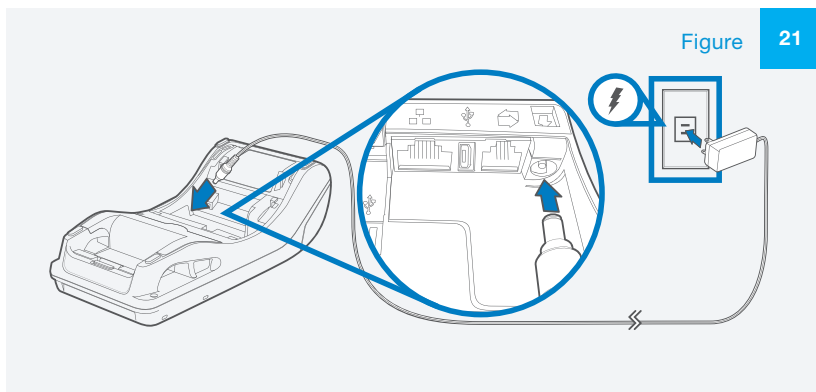

Figure 20



## CONNECTING THE TERMINAL'S POWER SUPPLY

01. Remove the terminal's rear cover to access the power port.
02. Insert the round barrel connector (see figure 21) into the power port.
03. Route the cable in the direction of the arrow above the power port and sling the cable over the underside of the thermal paper container.
04. Close the terminal's rear cover.
05. Plug the AC power pack into a wall outlet or powered surge protector (see figure 22).



## HOW TO USE THE TERMINAL'S CONTACTLESS READER

**To perform a contactless credit or debit card transaction:**

01. Gently tap or hold the card on the landing zone (*figure 23*).

02. A short beeping sound indicates a successful transaction.



Figure 23

## HOW TO USE THE TERMINAL'S CHIP CARD READER

**To conduct an EMV or chip credit or debit card transaction:**

01. Position a chip card with the contacts facing upward.

02. Insert the chip card into the chip card reader slot in a smooth,

continuous motion until it seats firmly (*figure 24*).

03. Remove the card only when the application indicates the transaction is complete.

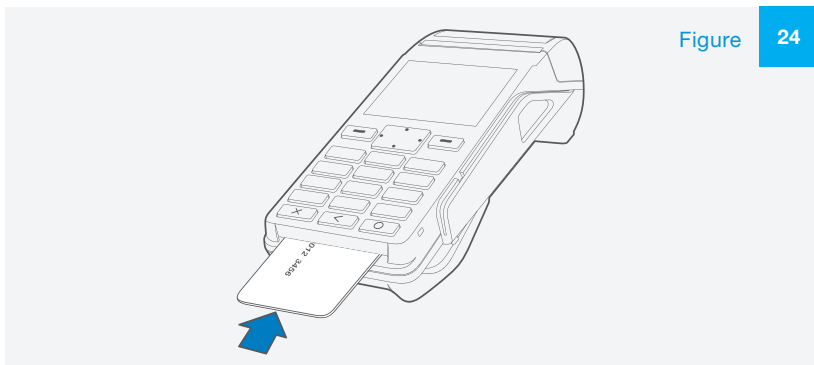
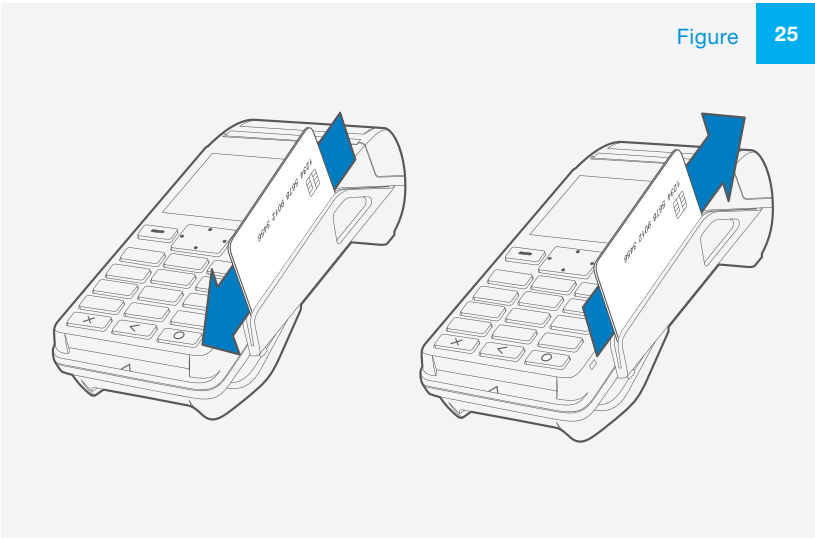

Figure 24

## HOW TO USE THE TERMINAL'S MAGNETIC CARD READER

### To conduct a credit or debit magstripe card transaction:

01. Position the card with the magnetic stripe oriented downward, facing the keypad.
02. To ensure a proper read of the magnetic stripe, swipe the card smoothly through the reader in one direction (either towards the top of the screen or the bottom of the keyboard).
03. Check the screen for confirmation of a successful transaction.



## LOADING A TERMINAL ROLL

Before you can process transactions that require a receipt, you must install paper into the printer.

01. Unlock the paper compartment by pulling up the latch and swinging the door downwards.
02. Remove any partial roll of paper in the printer tray by lifting it up.
03. Loosen the glued leading edge of the new paper roll or remove the protective strip. Unwind the paper roll past any glue residue.
04. Hold the roll, so the paper feeds from the bottom of the roll.
05. Load the paper roll as shown in *Figure 26*, with the edge of the paper on the top of the roll.
06. Swing the paper roll cover until it clicks shut, allowing a small amount of paper (past the glue residue) to extend outside the printer door.

### Note:

- A pink out-of-paper indicator line appears on the edge of the paper before the end of the roll. After this line appears, there is enough paper remaining on the roll to print at least one more transaction receipt.
- If the printer is not printing the receipt, the merchant should turn the roll over.
- It is important to note that our printers are thermal printers and do not use ink.

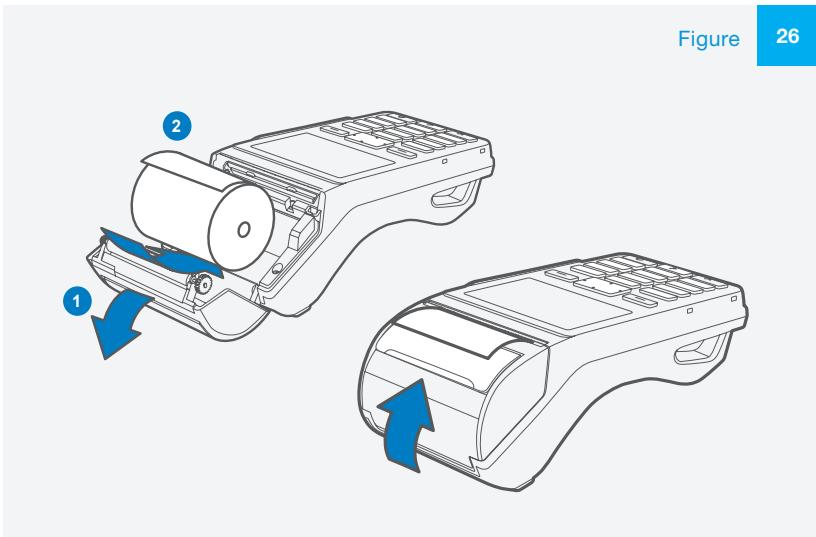





Verifone  
Rewards Earned

25 Points Earned

These points have been added to your total points.

100 Total Points

150 Next Reward

You are only 30 points away from your next reward.

OK

# V240m+

---

The V240m+ offers a smooth point-of-sale experience due to the state-of-the-art technology within its features, functionality, and performance. Both efficient and cost-effective, it is a great addition to Verifone's Engage portfolio that allows for more advanced capabilities, like paying with points, digital couponing, and other value-added services.

The V240m+ will make your customers' transactions at pay-at-the-table, curbside delivery, kiosks, and line-busting a breeze.

---



# V240m+

## NAVIGATIONAL COMPONENTS OF V240m+

The V240m+ is characterized by a touch screen that enables easy menu control. Its sleek and stylish shape occupies minimal counter space, while its bold and ergonomic design can fit comfortably in the palm of a hand.

## TERMINAL FEATURES

The V240m+ includes the following features:

- Capacitive touch LCD display and Contactless tap area.
- EMV Chip card reader.
- Magnetic Stripe card reader.
- Integrated thermal printer.
- Secure keypad (supporting 3x5 matrix containing 0-9, \*, #, 'Cancel', 'Backspace/Clear', and 'Enter' keys).

After removing the rear cover, the underside of the V240m+ device (*figure 27*) shows the following:

- Dual Sim slots.
- Battery.

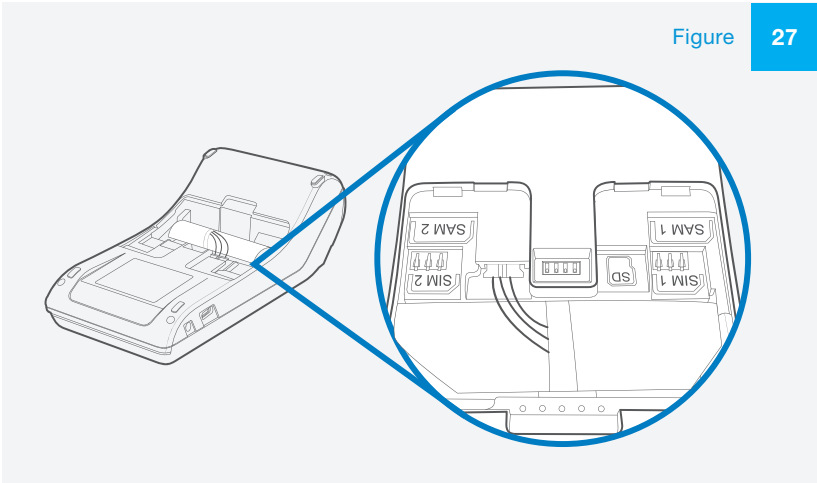

## SETTING UP WI-FI CONNECTIVITY

01. From the Main Menu screen, press '#’.
02. Select 'Management’.
03. Select 'Settings’.
04. Select 'Communications’.
05. Enter the Manager password to set up terminal connectivity (LAN, Wi-Fi, etc.).
06. Select 'Wi-Fi' (terminal scans for Wi-Fi networks).
07. Choose from the list of Wi-Fi networks.
08. Input the Wi-Fi password, then press 'Enter’.
09. Press 'Enter' to exit after the Wi-Fi password is accepted.

### Note:

- To utilize special characters for your Wi-Fi password, select the asterisk symbol (\*), the number key zero (0), and the pound key (#) in that order; in quick succession, to produce a variety of special characters.
- The asterisk (\*) symbol produces the following characters: , ‘ “
- The zero (0) key produces the following characters: - +
- The pound key (#) produces the following characters: ! : ; @ = & / \ % \$ ( ) ^ \_

## CONNECTING THE TERMINAL POWER SUPPLY

01. Insert the round barrel connector into the power port.
02. Plug the AC power pack into a wall outlet or powered surge protector.

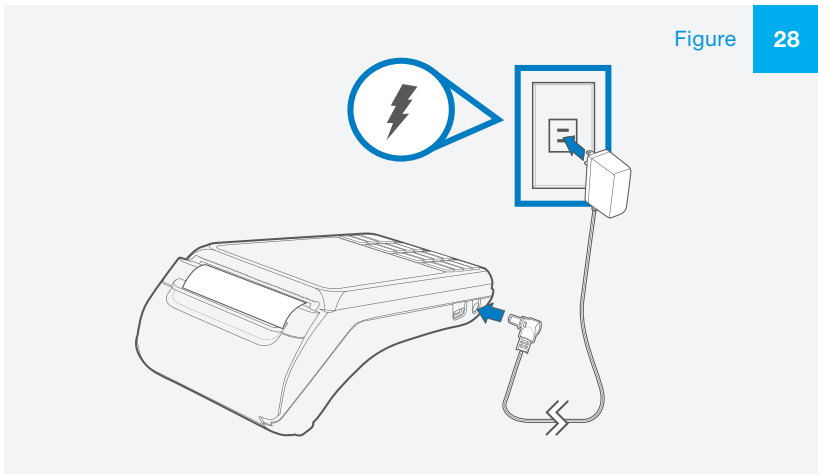

Figure 28

## HOW TO USE THE TERMINAL'S CHIP CARD READER

### To conduct an EMV or chip credit or debit card transaction:

01. Position the chip card with the contacts facing upward.
02. Insert the chip card into the chip card reader slot in a smooth, continuous motion until it seats firmly (*figure 29*).
03. Remove the card only when the application indicates the transaction is complete.

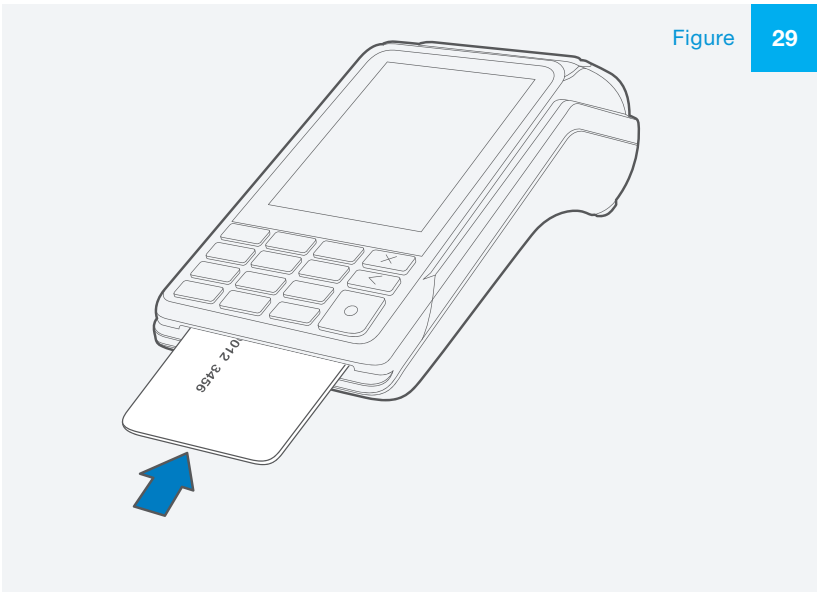

Figure 29

## HOW TO USE THE TERMINAL'S MAGNETIC CARD READER

### To conduct credit or debit magstripe card transactions:

01. Position the magnetic card with the stripe facing the keypad.
02. Swipe it through the magnetic card reader.

OR

01. Position the card with the magnetic stripe facing the keypad.

02. To ensure a proper read of the magnetic stripe, swipe the card smoothly through the reader in one direction (either towards the top of the screen or the bottom of the keyboard).
03. Check the screen for confirmation of a successful transaction (*figure 30*).

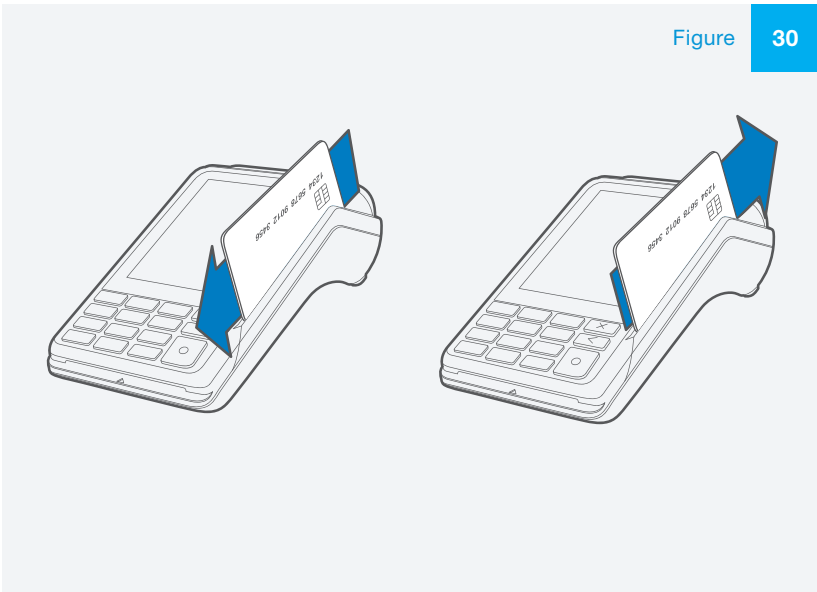

## HOW TO USE THE TERMINAL'S CONTACTLESS READER

### To perform a contactless credit or debit card transaction:

01. Gently tap or hold the card on the landing zone.
02. An activated LED visual on the display accompanied by a short beeping sound indicates a successful transaction.



## LOADING A TERMINAL ROLL

Before you can process transactions that require a receipt, you must install paper into the printer.

01. Unlock the paper compartment by pulling up the latch and swinging the door downwards (figure 32).
02. Load the paper roll as shown in Figure 33, with the edge of the paper on the top of the roll.
03. Pull a length of paper up over the serrated cutter and close the compartment door (figure 34).

### Note:

- A pink out-of-paper indicator line appears on the edge of the paper before the end of the roll. After this line appears, there is enough paper remaining on the roll to print at least one more transaction receipt.
- If the printer is not printing the receipt, the merchant should turn the roll over.
- It is important to note that our printers are thermal printers and do not use ink.

Figure 32

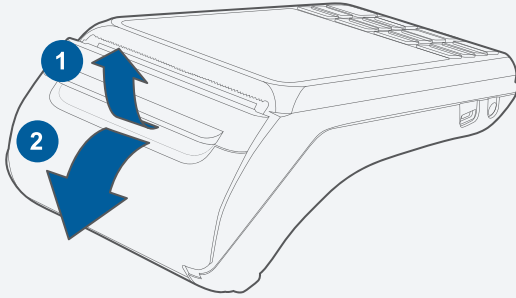

Figure 33

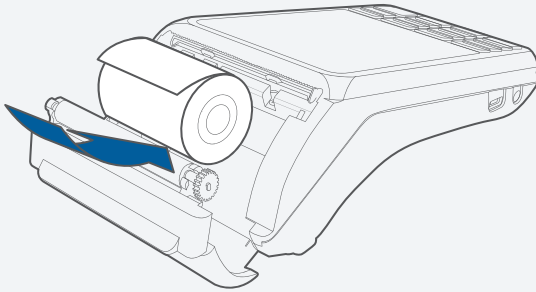
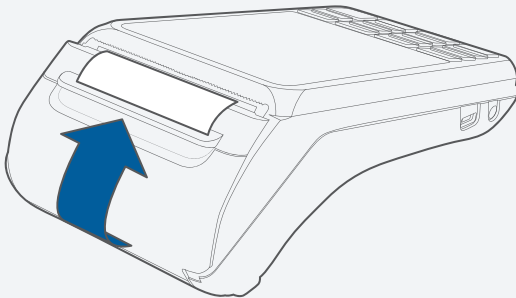

Figure 34







# START-UP INSTRUCTIONS AND ACCESS MANAGEMENT

---



## START-UP INSTRUCTIONS

01. Long press the green 'Enter' key to power on the terminal.
02. Once on the Main Menu, press 'Enter' to get started.

## USER ACCESS MANAGEMENT

### Clerk Management

- After entering the Main Menu, select 'Management'.
- Then, select 'Manage Clerk'.

In the initial login session, you can choose to enable or disable the default Clerk mode, which allows the machine to generate a Clerk report for all active Clerk set-ups on the terminals.

After the initial log-on, you can choose to 'Add Clerk', 'View Clerk', 'Modify Clerk', and 'Delete Clerk' once you enter the 'Manage Clerk' screen.

- Add Clerk – allows the Manager to add a new Clerk (i.e., Clerk ID and Password).
- View Clerk – allows the Manager to view the Clerk's set-up on the terminal.
- Modify Clerk – allows the Manager to change the Clerk's username and password.
- Delete Clerk – allows the Manager to delete the Clerk(s).

### Steps to Add a Clerk:

01. To add a Clerk profile, select 'Management', then 'Manage Clerk', then 'Add Clerk' from the Main Menu.
02. Enter your (Manager) password.
03. Ask the Clerk to create and enter their Clerk ID/Username\*.
04. Then, ask the Clerk to create and enter their Clerk Password.
05. Ask the Clerk to re-enter the Clerk Password created.

06. The Clerk profile will then be successfully added to the database.

#### Note:

- *The Clerk ID can comprise alpha-numeric and numerical characters.*
- *The Merchant has the autonomy to determine the Clerk set-up.*

## Steps to Login Clerk:

01. From the Main Menu, select 'Management', then 'Manage Clerk'.
02. Scroll down to the screen that shows the options 'Login Clerk' and 'Logoff Clerk'.

### Note:

- *You can scroll down by using the navigation button if you are using a V200c+ or V200t+ terminal, or you can scroll down using the arrow on the screen if you are using the V240m+ terminal.*

03. Select 'Login Clerk'.
04. You will see a list of all the Clerk profiles created.
05. Select the Clerk profile you wish to log into.
06. Ask the Clerk to enter their password.
07. The selected Clerk profile will then be successfully logged in.

## Steps to Logoff Clerk:

01. From the Main Menu, select 'Management', then 'Manage Clerk'.
02. Scroll down to the screen that shows the options 'Login Clerk' and 'Logoff Clerk'.

### Note:

- *You can scroll down by using the navigation button if you are using a V200c+ or V200t+ terminal, or you can scroll down using the arrow on the screen if you are using the V240m+ terminal.*

03. Select 'Logoff Clerk'.
04. You will be prompted to confirm that you wish to logoff from the Clerk that is currently logged on to the terminal.
05. The selected Clerk profile will then be successfully logged off.

# SALE

---



## SALE

01. To get started, press the pound key (#), then select 'Transactions' from the Main Menu.
02. Select 'Sale'.
03. To specify the currency, select '1 JM\$' for Jamaican dollars, or select '2 US\$' for US dollars.
04. Type in the transaction amount and press 'Enter'.
05. Enter the Clerk Password and press 'Enter' (if a Clerk is not yet logged on, they will be prompted to log on).
06. Allow the Customer to INSERT or SWIPE their card, or TAP their card, device, or wearable (if the card details are not inputted within 1 minute, the screen will return to the Main Menu).
07. If a PIN is required, allow the Customer to enter their PIN.
08. Upon approval after processing, a Merchant receipt will be printed.
09. Press 'Enter' to print the Customer receipt if required; if not, press 'Cancel'.
10. If the card was inserted, allow the Customer to remove their card at the end of the transaction.

## SALE – CARD NOT PRESENT

*Applicable to approved Merchants only.*

- If the card is not present for the transaction, enter the Card Number manually.
- Enter the Expiry Date (MM/YY).
- Enter the Card Verification Value (CVV).
- Select the 'Card Present' mode, whether it is 'Card Present', 'Mail Order', or 'Phone Order'.
- After approval, a Merchant receipt will be printed.
- Press 'Enter' to print the Customer receipt or 'Cancel', if not required for the completion of the transaction.

### Note:

- *Card Present – A Card Present (CP) transaction occurs when the Cardholder is present at the Merchant location with a card, device, or wearable, to conduct the transaction.*
- *Mail Order Telephone Order (MOTO) – is a transaction that is initiated by the Cardholder communicating the purchase request with the Merchant via email, facsimile, or other electronic means or by telephone.*

## SALE – CARD NOT PRESENT (continued)

If a CVV is not available, follow these steps:

Figure 35

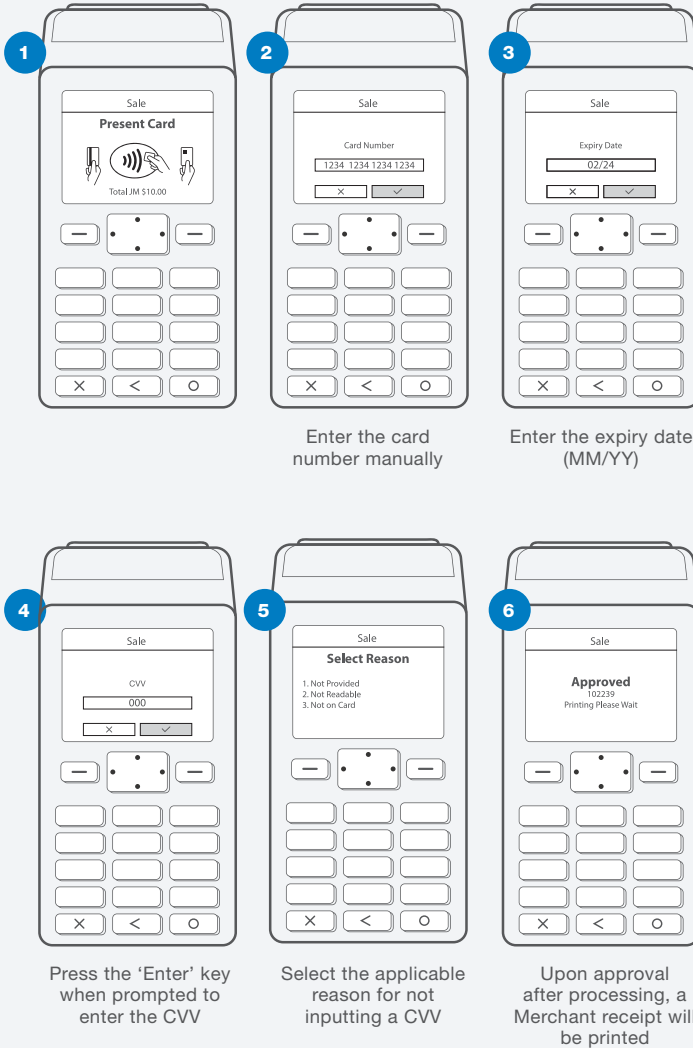



# PRE-AUTHORIZATION AND PRE-COMPLETION

---



## PRE-AUTHORIZATION

01. From the Main Menu, press the pound key (#) and select 'Transactions'.
02. Select 'Reservation'.
03. On the 'Reservation' screen, select 'PreAuth'.
04. To specify the currency, select '1 JM\$' for Jamaican dollars, or select '2 US\$' for US dollars.
05. Enter PreAuth amount.
06. Enter Clerk Password.
07. Enter the Card Number manually, or allow the Customer to INSERT their card or SWIPE their card, or TAP their card, device, or wearable.
08. If a PIN is required, allow the Customer to enter their PIN.
09. Upon approval after processing, allow the Customer to remove their card if a card was inserted.
10. A Merchant receipt will be printed.
11. Press 'Enter' to print the Customer receipt if required; if not, press 'Cancel'.

## PRE-COMPLETION

01. From the Main Menu, press the pound key (#) and select 'Transactions'.
02. Select 'Reservation'.
03. On the 'Reservation' screen, select 'PreAuth Completion'.
04. Enter the 'Reference Number'.
05. Confirm the PreAuth transaction for Completion.
06. Enter the Pre-Completion amount.
07. Enter the Clerk Password.
08. Upon approval after processing, a Merchant receipt will be printed.
09. Press 'Enter' to print the Customer receipt if required; if not, press 'Cancel'.



# REFUND & VOID

---



## REFUND

01. From the Main Menu, press the pound key (#) and select 'Transactions'.
02. On the 'Transactions' screen, select 'Refund'.
03. Enter your Manager Password.
04. Enter the Refund amount.
05. Enter the Transaction ID (RRN).
06. Enter the Clerk's Password.
07. Enter the Card Number manually, or allow the Customer to INSERT their card or SWIPE their card, or TAP their card, device, or wearable.
08. Upon approval after processing, a Merchant receipt will be printed.
09. Press 'Enter' to print the Customer receipt if required; if not, press Cancel.

### Note:

- *Refund transactions do not apply to Multilink Cards. Where required, these transactions should be voided prior to settlement.*

## VOID

01. From the Main Menu, press the pound key (#) and select 'Transactions'.
02. On the 'Transactions' screen, select 'Void'.
03. Enter your (Manager) Password.
04. To specify the currency, select '1 JM\$' for Jamaican dollars, or select '2 US\$' for US dollars.
05. Select the method of identifying the Void transaction (press '1' for 'Invoice Number' or press '2' for 'Last Transaction').
06. Enter the Clerk's Password.
07. If the option 'Invoice Number' was selected, enter the Invoice Number.
08. Press 'Enter' to confirm the transaction to Void.
09. Upon approval after processing, a Merchant receipt will be printed.
10. Press 'Enter' to print the Customer receipt if required; if not, press 'Cancel'.
11. If the option 'Last Transaction' was selected, press 'Enter' to confirm the transaction to Void.
12. Upon approval after processing, a Merchant receipt will be printed.
13. Press 'Enter' to print the Customer receipt if required; if not, press 'Cancel'.

### Note:

- *For Multilink transactions to be voided, these should be completed before 9:00 p.m.*



# TERMINAL ADMINISTRATION, MANAGEMENT, AND SETTLEMENT

---



## ADMINISTRATION MENU

- From the Main Menu, press the pound key (#) and select 'Administration'.
- The menu options available under the Administration menu will include 'Batch', 'Duplicate', and 'Reports'.

### Batch

- Select 'Batch'.
- Choosing 'Batch Review' will allow you to review transactions in the Batch.
- Choosing 'Batch Settlement' will allow you to select the currency to be settled or to settle all batches and print a Detail Report.

### Reprint

- Select 'Reprint'.
- Choosing 'Reprint Last Receipt' will allow you to Reprint the last receipt in the Batch.
- Choosing 'Reprint Any Receipt' will allow you to select the receipt to be printed by entering the Invoice Number for the required receipt.
- Choosing 'Reprint Settlement' will allow you to Reprint the settlement report.
- Choosing 'Reprint Last Reversal' will allow you to Reprint the last refund.

### Reports

- Select 'Reports'.
- Choosing 'Detail Report' will allow you to print the Detail Report.
- Choosing 'Totals Report' will allow you to print the Totals Report.
- Choosing 'PreAuth Report' will allow you to print the PreAuth Report.
- Choosing 'Clerk Report' will allow you to print the Clerk Detail Report and/or the Clerk Totals Report (The Totals Report is only available with Clerk Mode on).

### Settling the Terminal

- From the Main Menu, press the pound key (#)
- Select 'Administration'
- Select 'Batch'
- Select 'Settlement'
- Select the currency to be settled  
OR Select all batches
- Allow the detailed report to print
- Your device will then display the message 'Grand Total and Settlement Successful'

## MANAGEMENT MENU

- From the Main Menu, press the pound key (#) and select 'Management'.
- The menu options available under the Management menu will include 'About', 'Settings', 'Diagnostics', and 'Manage Clerk'.

### About

- Select 'About' to access information on various software and components within the terminal (such as version, status, etc.).
- You can confirm terminal details to troubleshoot for resolution of issues using this feature by selecting the right key on the navigation pad or touchscreen (where applicable) to navigate through the various Settings options.

### Settings

- Select 'Settings'.
- After choosing 'Settings', press '#' to view extended options.
- Choosing 'Communication' will allow you to set up your terminal's connectivity mode (Ethernet/LAN, Wi-Fi, and GPRS).

### Diagnostics

**\*Ensure that you settle all transactions before attempting this function\***

- Select 'Diagnostics'.
- Choosing 'COMMS TEST' will allow you to verify terminal connectivity.







# CONNECTIVITY OPTIONS

---



## CONNECTIVITY OPTIONS

Terminal Connectivity Order of Preference  
(Order of Preference is universal across all terminal models).

	Ethernet (Wired Internet Connection)
	Wi-Fi
	GPRS/Data SIM
	Dial-up/Phone Line

## HOW TO LOG IN TO THE WI-FI

### Steps (applicable to all terminals):

01. Press the pound key (#) from the main screen.
02. Select 'Management'.
03. Select 'Settings'.
04. Select 'Communications'.
05. Enter the Manager's password.
06. You will see all communication modes; select 'Wi-Fi'.
07. You will see a list of all the available Wi-Fi networks.
08. Select the desired Wi-Fi network.
09. Enter Wi-Fi password.
10. Press 'Enter' to exit after Wi-Fi is accepted.

### Note:

- To utilize special characters for your Wi-Fi password, select the asterisk symbol (\*), the number key zero (0), and the pound key (#) in that order; in quick succession, to produce a variety of special characters.
- The asterisk (\*) symbol produces the following characters: , ' "
- The zero (0) key produces the following characters: - +
- The pound key (#) produces the following characters: ! : ; @ = & / \ % \$ ( ) ^ \_



# TERMINAL CARE AND MAINTENANCE

---





---

## TERMINAL CARE AND MAINTENANCE IN 7 EASY STEPS:

- 1 Always leave your Point-of-Sale Terminal on to receive the latest application and security updates.
- 2 Let your Point-of-Sale Terminal update by connecting via Ethernet or Wi-Fi. Always allow it to finish; do not cancel the update.
- 3 Make sure your Point-of-Sale Terminal is fully charged and ready for each day.
- 4 Handle your Point-of-Sale Terminal with care. Do your best not to drop the device or spill any liquids on it, as this will affect the device's functionality.
- 5 Keep your device in a safe and visible location and conduct routine checks to ensure no unknown peripherals were installed.
- 6 It is recommended to plug the terminal into a surge protector versus a wall outlet.
- 7 Be sure to keep your terminal at a normal temperature (extreme heat or cold can influence functionality).

## TERMINAL BATTERY AND USAGE

- 1 If the terminal's battery percentage is below 25%, a message stating, "Battery Low connect charger" will appear on the terminal's screen. However, it will complete its operation smoothly without interference while conducting a normal transaction.
- 2 When the battery percentage reaches 9%, the terminal will not conduct the transaction and a message stating, "Battery critical connect charger" will appear.

---

## PASSWORD MAINTENANCE

- The Manager password will expire every 90 days. Merchants are encouraged to ensure that these passwords are changed once they are prompted by the terminal.
- The Manager password can be used to change the Clerk password on the terminal.
- Select the pound key (#).
- Go to the Management Menu.
- Select the 'Settings' option.
- Press the pound key (#).
- Select the 'Change Password' option.

## SECURITY TIPS

**Periodically inspect the terminal for possible tampering. Signs of tampering may include:**

- 1 Wires protruding from the device.
  - 2 Foreign objects inserted into the smart card or mag stripe slot.
  - 3 Signs of damage to the tamper-evident label.
  - 4 A warning message on the device display.
- 

Check to make sure that no cameras can capture the Cardholder's PIN, and immediately report a missing terminal or signs of tampering/altering the terminal.

## MERCHANT SUPPORT CHANNELS:

Should you have any questions or concerns about your terminal, or need assistance with resetting your terminal password or processing transactions, please feel free to contact our Merchant Support Team using the channels provided below.

**Our Team is always ready to assist you!**



Merchant Support  
Direct Line  
**876-935-2600**



Merchant Support Email  
**[ncbinfo@jncb.com](mailto:ncbinfo@jncb.com)**



Web Chat Support  
**[www.jncb.com](http://www.jncb.com)**



WhatsApp  
**876-469-2230**



 Merchant Support Direct Line: **876-935-2600**

 WhatsApp: **876-469-2230**

 Merchant Support Email: **ncbinfo@jncb.com**

 Web Chat Support: **www.jncb.com**